

Handling instructions

**Silent Tools™**  
Milling adaptors

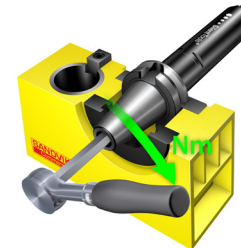

●●●● SilentTools®

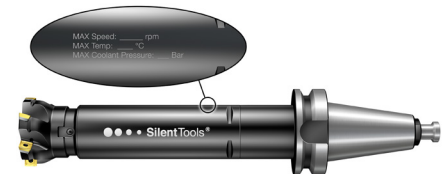
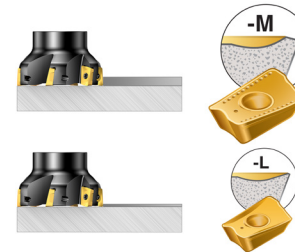
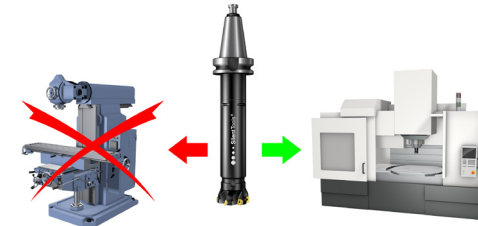
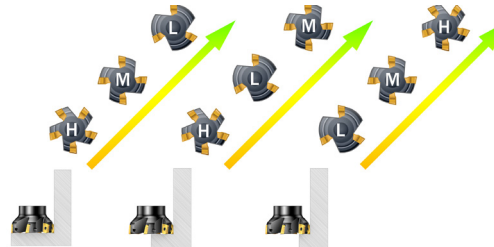
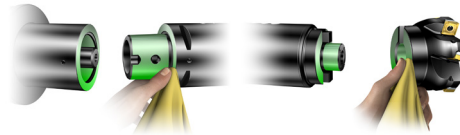
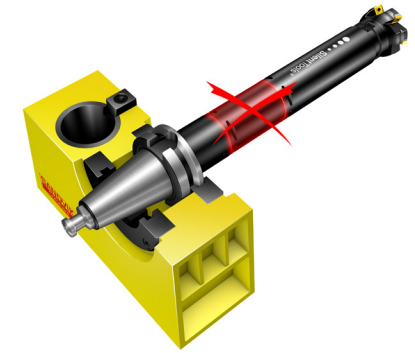
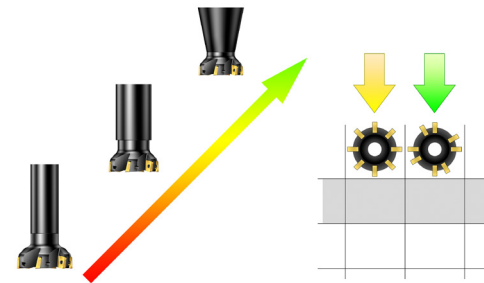
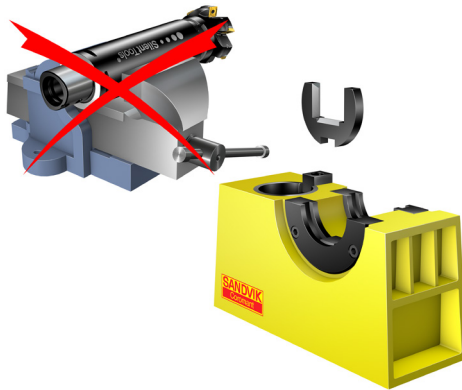

Head office:  
AB Sandvik Coromant  
SE-811 81 Sandviken, Sweden  
www.sandvik.coromant.com  
E-mail: info.coromant@sandvik.com

92020  
© AB Sandvik Coromant  
2014.05

Adaptors	Max torque	
	Nm	ft-lbs
Cx-391.05CD-16 xxx	22	16
Cx-391.05CD-22 xxx	45	33
Cx-391.05CD-27 xxx	80	59
Cx-391.05CD-32 xxx	180	133
Cx-391.05CD-40 xxx	300	220
Cx-A391.05CD-19 xxx	25	18
Cx-A391.05CD-25 xxx	65	48
Cx-A391.05CD-38 xxx	220	162

Coromant Capto size	Max torque	
	Nm	ft-lbs
C3	45	33
C4	55	40
C5	95	70
C6	170	125
C8	170	125
C10	380	277



Silent Tools™ Application guide  
www.sandvik.coromant.com